

PT 180

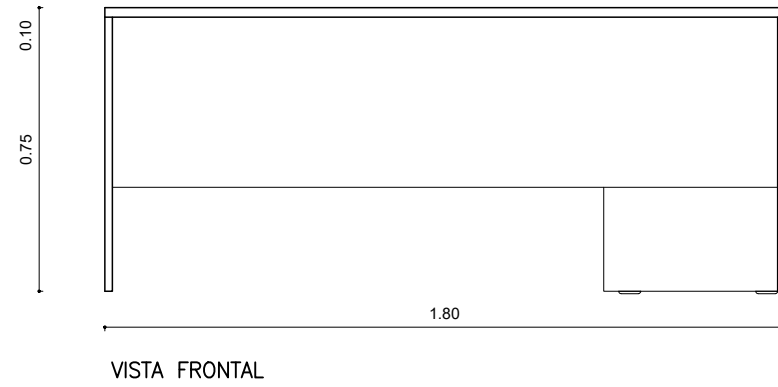

BP 90

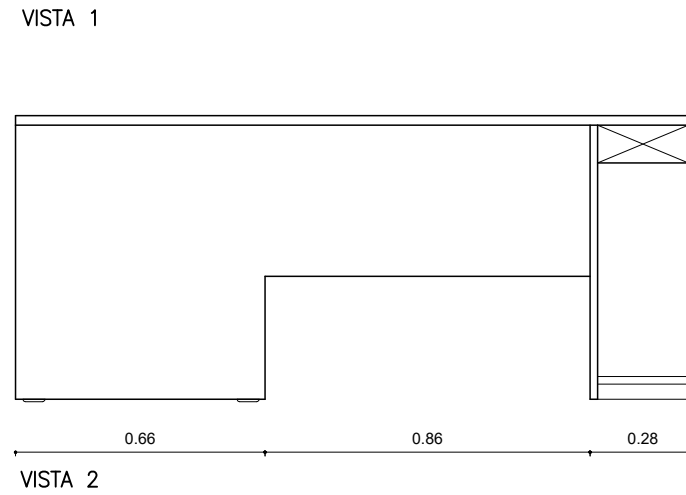
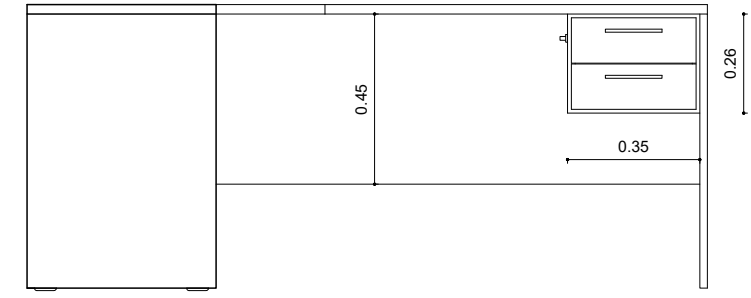
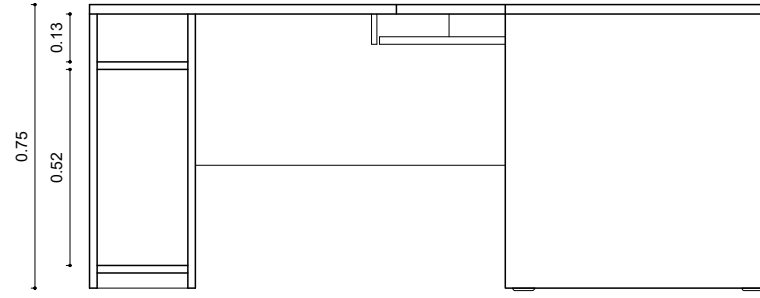
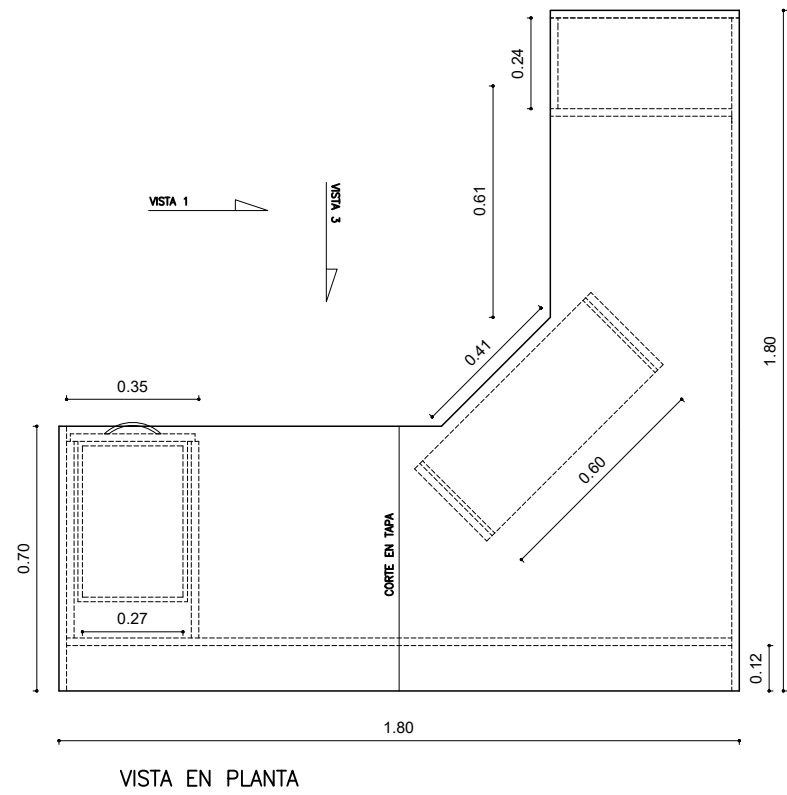
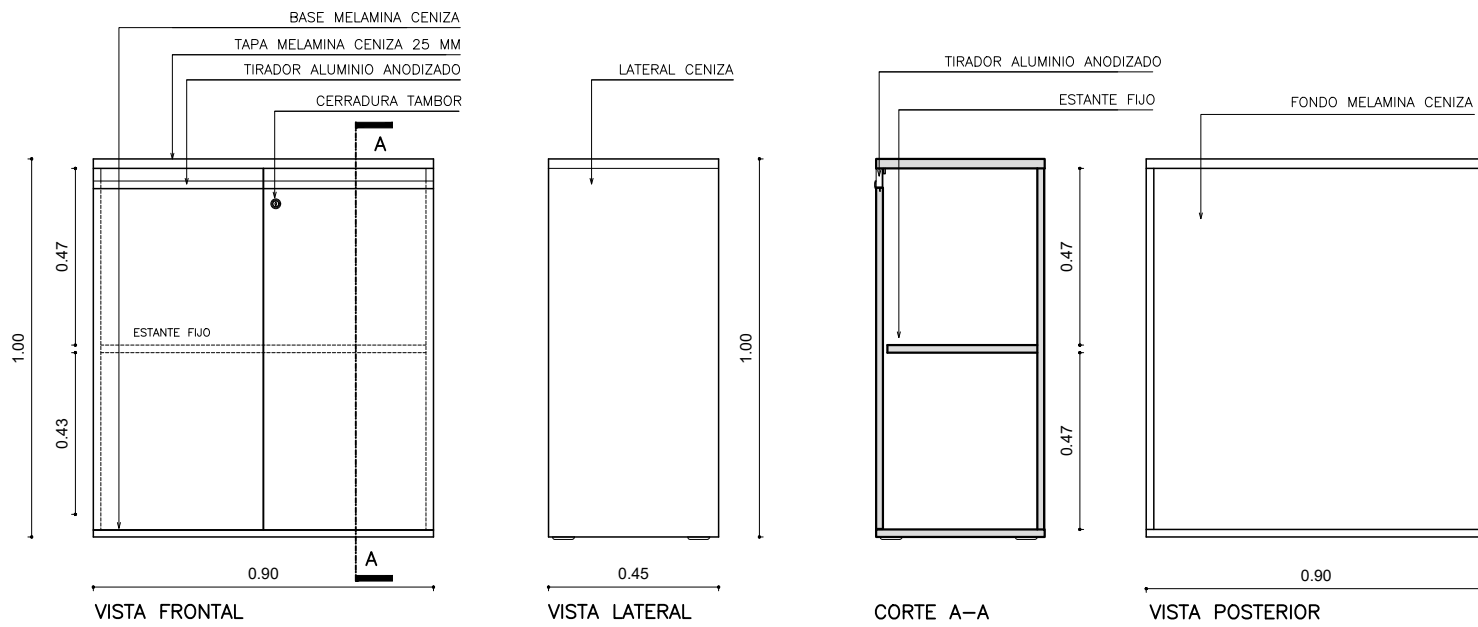

CR

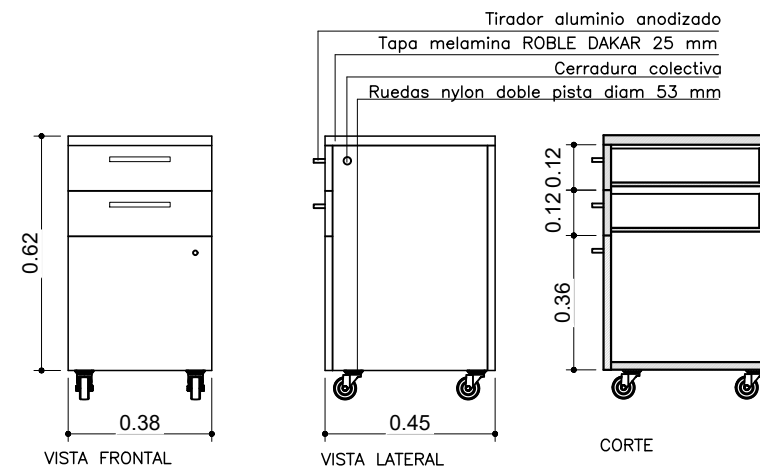

PODER JUDICIAL
DE LA PROVINCIA
DE SANTA FE

OFICINA DE ARQUITECTURA
DEL PODER JUDICIAL DE SANTA FE

OBRA:
MOBILIARIO PARA
TRIBUNALES DE
SAN CRISTÓBAL

PLANO N°:

M-03