

ESCRITORIO EMPLEADOS (ET140)

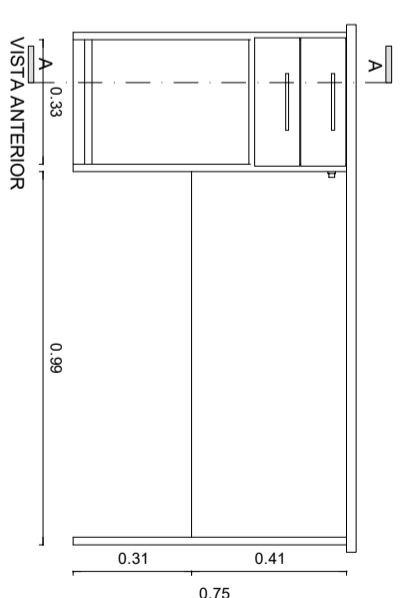

BIBLIOTECA CON PUERTAS JUEZ (BP120)

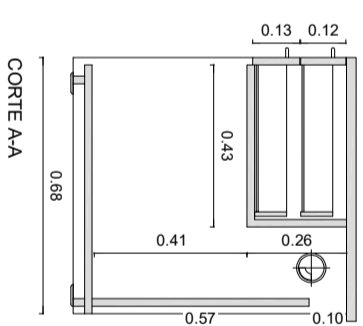
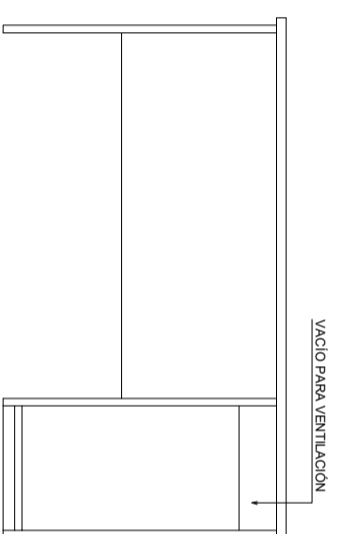
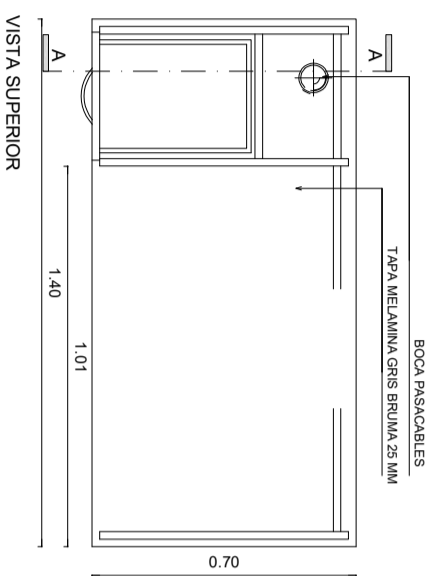
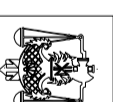
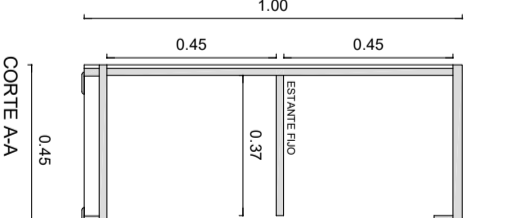
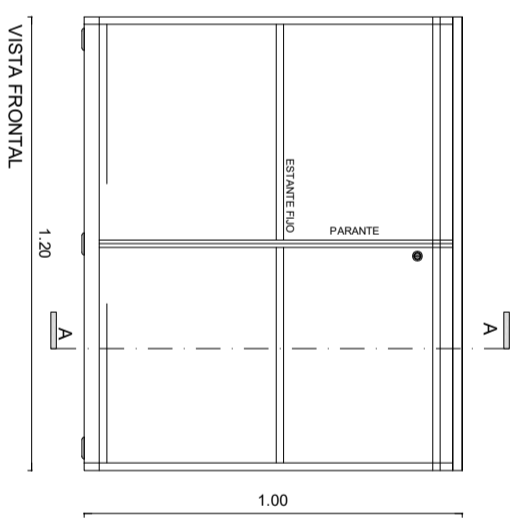
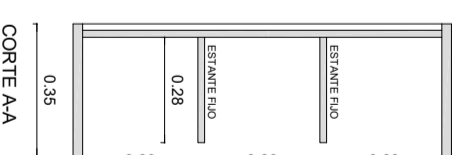
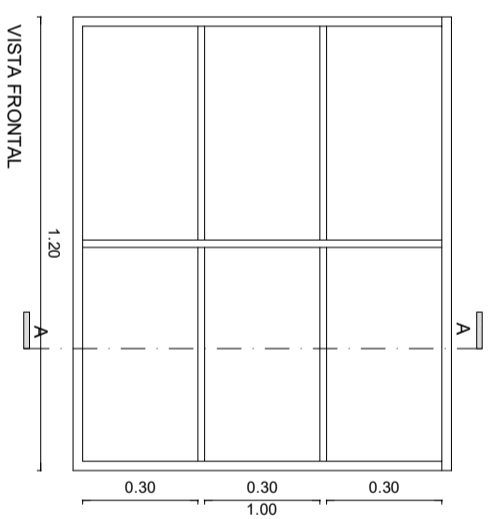
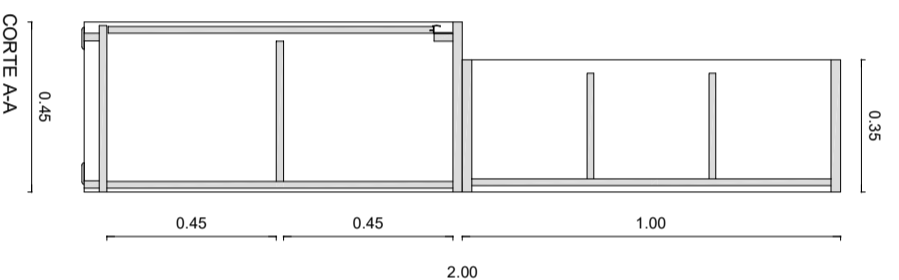
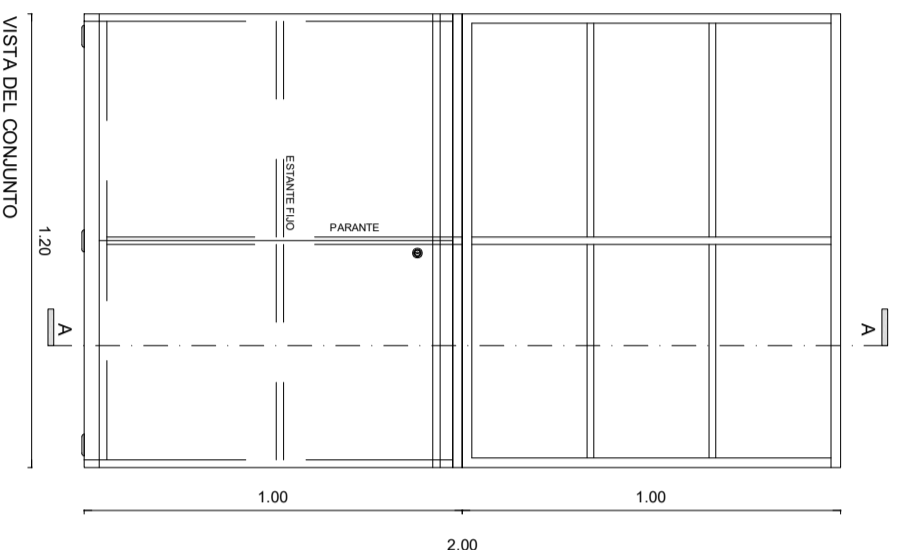

PLANO DE:
MOBILIARIO

ESCALA: S/E
PLANO:

PODER JUDICIAL DE LA PROVINCIA DE SANTA FE
Oficina de Arquitectura del Poder Judicial / Santa Fe

03

OBRA: JUZGADO DE CIRCUITO N° 21 HELVECIA