

BP90

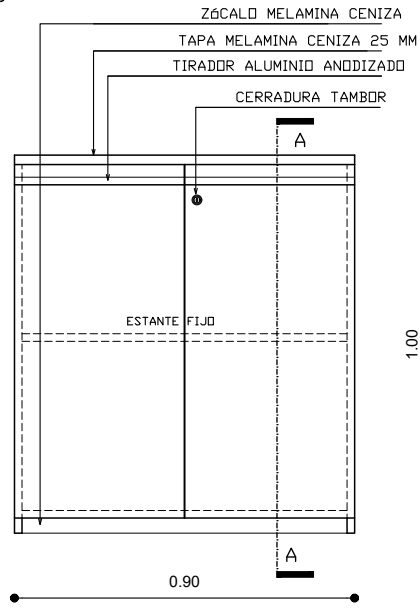

VISTA FRONTAL

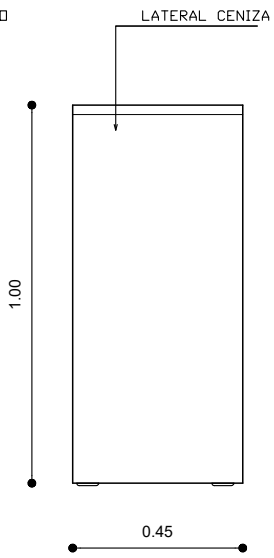

VISTA LATERAL

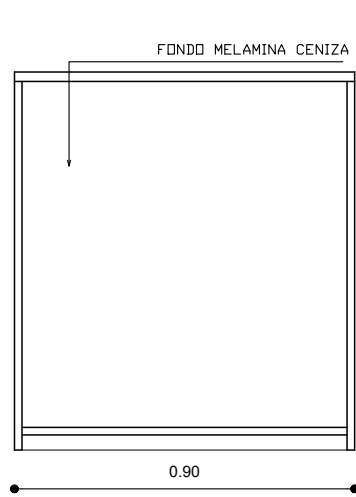

VISTA POSTERIOR

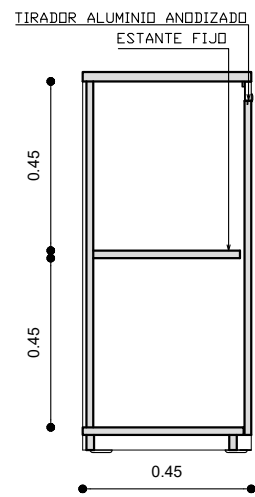

CORTE A-A

BP80

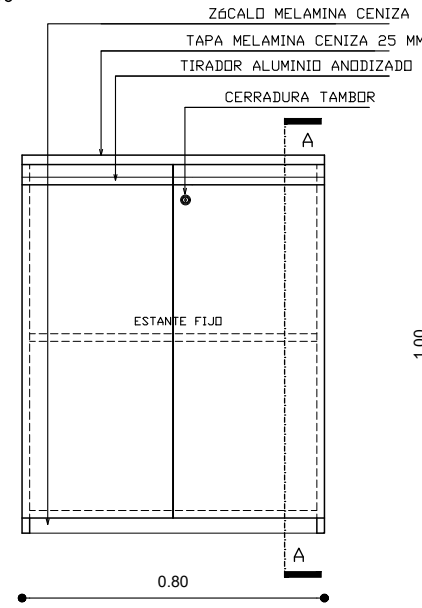

VISTA FRONTAL

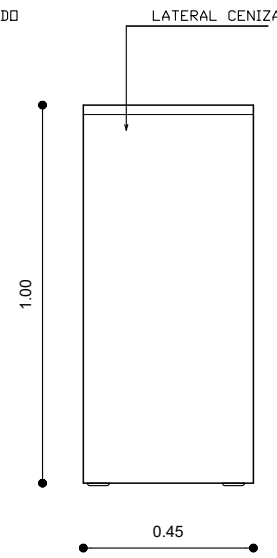

VISTA LATERAL

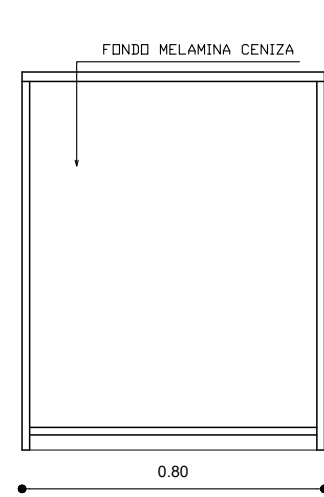

VISTA POSTERIOR

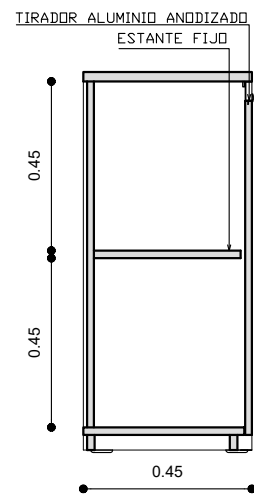

CORTE A-A

C01

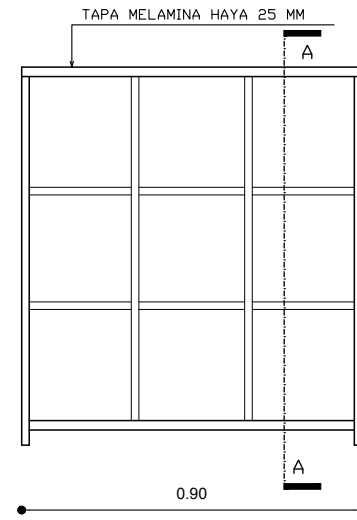

VISTA FRONTAL

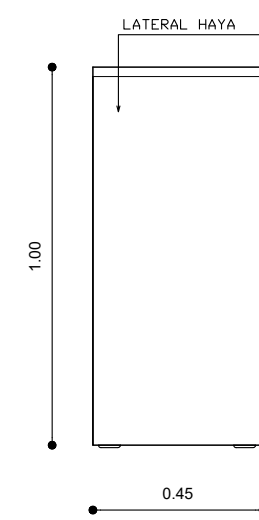

VISTA LATERAL

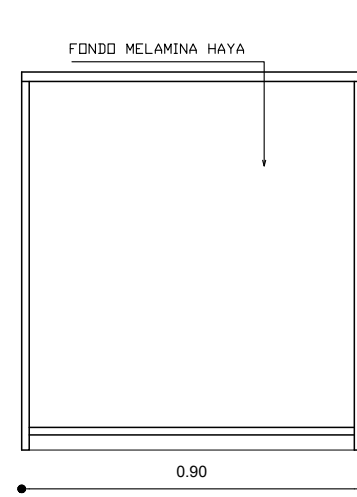

VISTA POSTERIOR

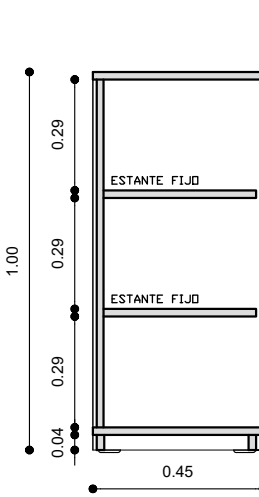

CORTE A-A

F01

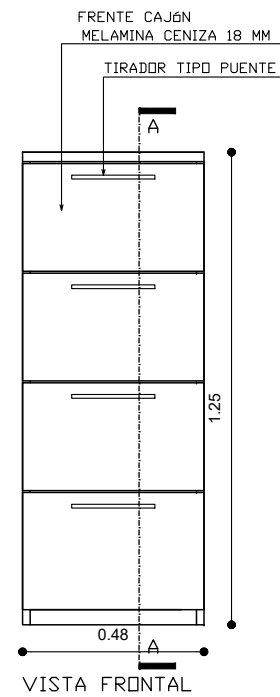

VISTA FRONTAL

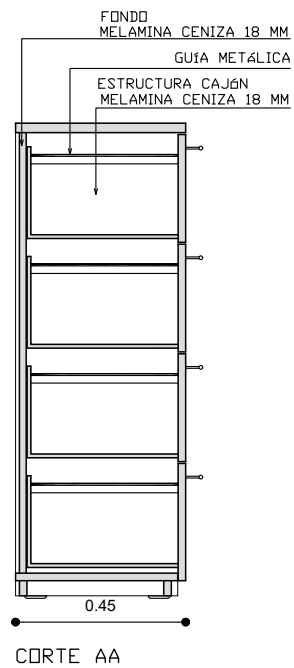

CORTE AA

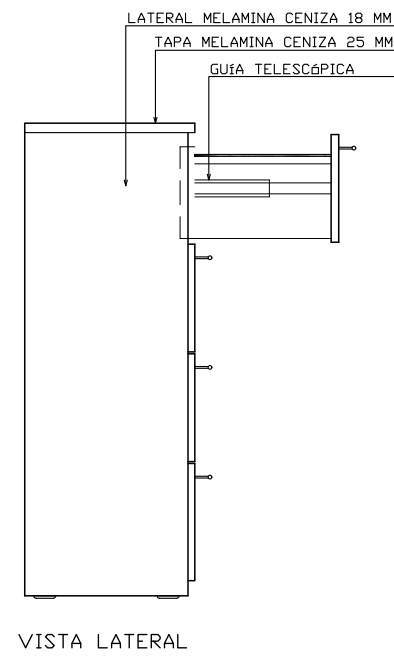

VISTA LATERAL



PLANO DE:	MOBILIARIO	ESCALA: S/E
PLANO:		
PODER JUDICIAL DE LA PROVINCIA DE SANTA FE		
Oficina de Arquitectura del Poder Judicial / Santa Fe		
		03
OBRA: Extracontractual-Secretaria 4.1/4.2 - San Jeronimo 1551 - SANTA FE		